

NOTES:

1. EXISTING EQUIPMENT.
2. PERMISSIBLE TO TRIM PARTS CREATED BY THIS DRAWING ON INSTALLATION AS REQUIRED.
3. TOUCH UP ALL BARE ALUMINUM SURFACES WITH ALODINE PER MIL-C-5541 CLASS 3.
4. PARENTHETICAL ENTITIES, ( ), ARE FOR REFERENCE ONLY.
5. LOCATE CIRCUIT BREAKER IN THE SAME GENERAL AREA WITH EXISTING CIRCUIT BREAKERS. LABEL AS SHOWN USING STANDARD ENGRAVING, SILKSCREEN, OR OTHER TECHNIQUES. LETTERING TO BE SAME HEIGHT AS EXISTING C/B LETTERING.
6. - - - - DENOTES EXISTING WIRES.
7. ALL GROUNDS GO TO NEAREST GROUND POINT ON AIRCRAFT.
8. TIE INTO EXISTING BUS BAR NEAR LOCATION OF NEW CIRCUIT BREAKER. IF A JUMPER WIRE IS REQUIRED, USE 20 GAUGE MIL-W-22759/XX TYPE.
9. BEST COMMERCIAL EQUIVALENT MAY BE SUBSTITUTED FOR THIS PART.
10. THE INSTALLATION OF WIRING TO BE PERFORMED IN ACCORDANCE WITH AC 43.13-1B, 2A, ACCEPTABLE METHODS, TECHNIQUES, AND PRACTICES - AIRCRAFT ALTERATIONS, CHAPTER 11. ALL WIRE TO BE MIL-W-22759/16 OR EQUIVALENT.
11. LETTERING TO BE .10 HIGH MINIMUM, WHITE, HELVETICA, LOCATED APPROX AS SHOWN. USE STANDARD SILKSCREENING, ENGRAVING OR PLACARD TECHNIQUES.
12. THE FOLLOWING IS A GUIDE FOR UNSWITCHED AUDIO PINOUTS. PINOUTS MUST BE VERIFIED WITH LATEST MANUFACTURER DRAWINGS.

REVISIONS			
REV	DESCRIPTION	DATE	APVD

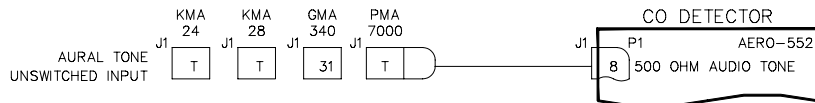
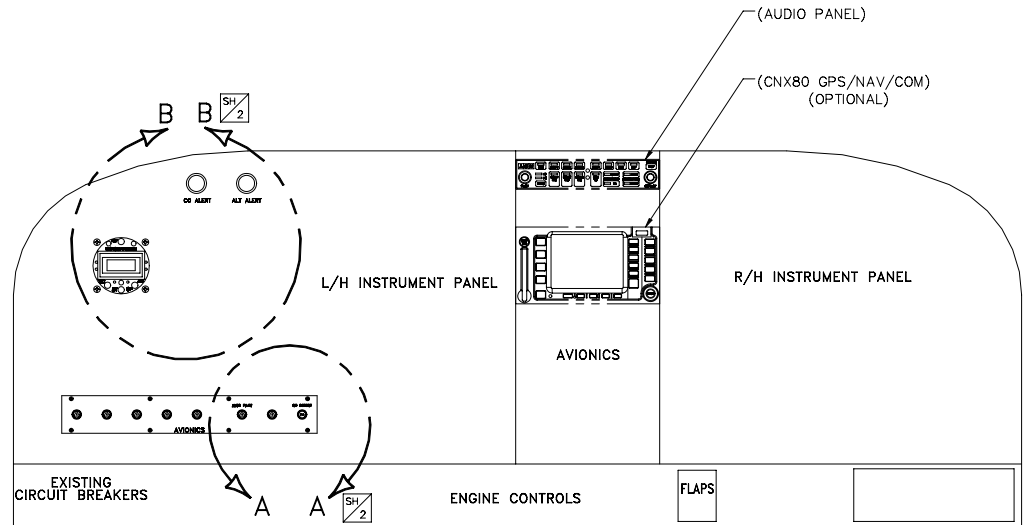

LOC: LH INSTRUMENT PANEL

13. ACTIVATE VOICE SYNTHESIZED AUDIO PANELS ON PRODUCTS SUCH AS PS ENGINEERING MODEL PMA 7000B PIN 20.
14. OPTIONAL IF CLOCK INSTALLED AWAY FROM PILOT'S REACH.

TYPICAL INSTRUMENT PANEL  
VIEW LOOKING FWD

ITEM	QTY	PART NUMBER	DESCRIPTION	VENDOR
7	1	C307PRF11	TEMP PROBE	DAVTRON
6	1	V313-.5	FUSE	ACC
5	2	855SI-A-3-DDS	LAMP	SOLAN
4	1	7277-2-2	CIRCUIT BREAKER	KLIXON
3	15	205090-1	PINS	AMP
2	1	205205-1	CONNECTOR	AMP
1	1	553	C O DETECTOR	C O GUARDIAN

PROPRIETARY NOTICE		PIVET CODES PER NAS223		APPROVALS		DATE		UNLESS OTHERWISE NOTED ALL DIM ARE IN INCHES	
This drawing contains specifications and/or data, technical material, proprietary designs and information that are the sole property of C O GUARDIAN, L.L.C., and treated by its recipient as a confidential item, and is not to be shown or disclosed to any unauthorized organization or person.		88 - MS20426AD		DESIGN	A. E. S.	03/25/04		TOLERANCES	
		89 - MS20470AD		DRAWN	ERIC WILSON	03/25/04		XXX ±.010 ANGLES	
				CHECK	MIKE GORDON	03/25/04		.XX ±.03	
				INSP.				.X ±.1	
UNLESS OTHERWISE NOTED, ALL BEND RAD TO BE 3 x MATL THICKNESS				PROJ.				FINISH	
				DASH	NEXT ASSY	REL.	ASH VIJ	SCALE	
						03/25/04		NONE	
								NONE	
								DRAWING NO.	
								01-553-01	
								SH 1 OF 3	
								REV IR	

FILENAME: 01-553-01IR2



TITLE  
CO DETECTOR INSTL.

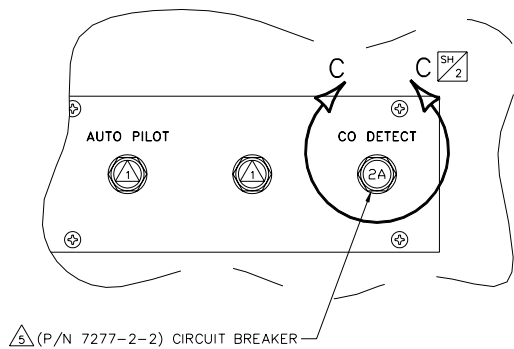

SECTION A SH 2

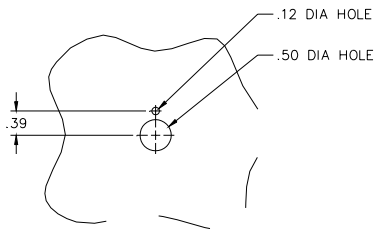

SECTION C SH 2  
C/B REMOVED FOR CLARITY

(855SI-A-3-DDS LAMP)  
.375 DIA. MOUNTING HOLE  
LOCATE APPROX AS SHOWN  
2 PL

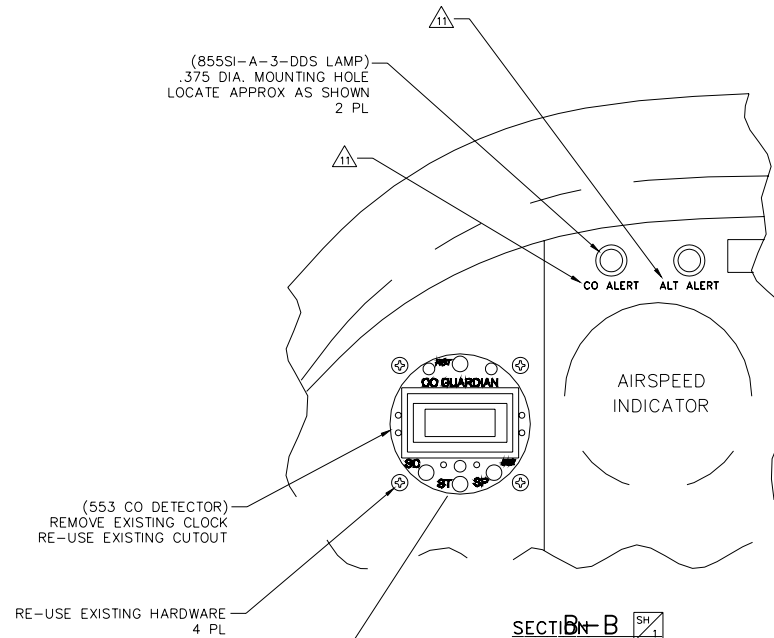

SECTION B SH 2

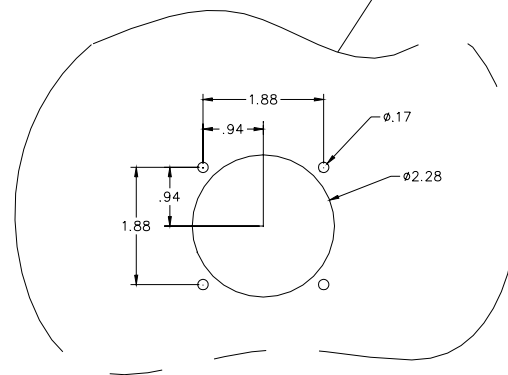

PANEL CUTOUT PATTERN

		1001 East Airport Drive Tempe, AZ 85281	
TITLE			
CO DETECTOR INSTL.			
DRAWING NO.		SH	REV
01-553-01		2	3
		IR	IR

FILENAME: 01-553-01R2

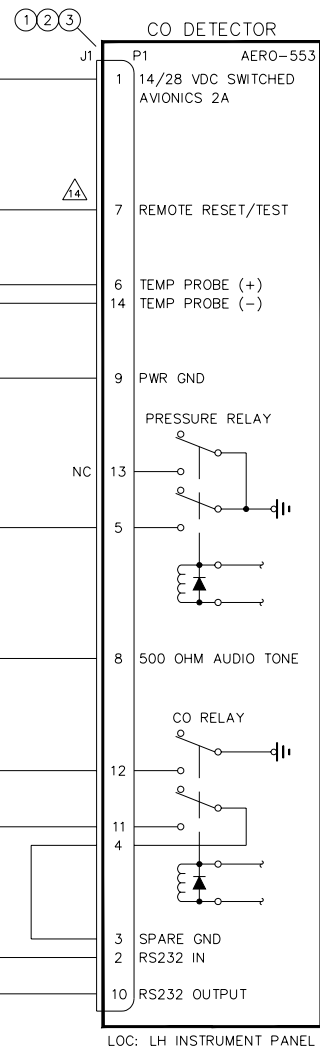
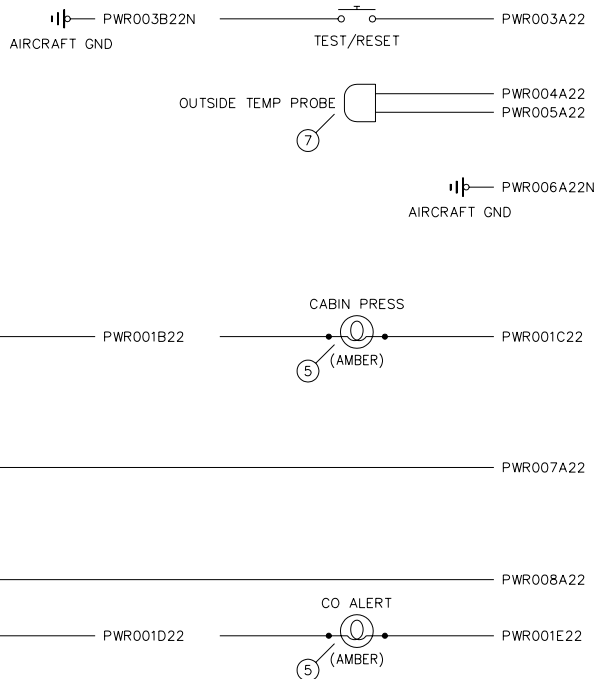
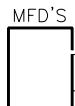
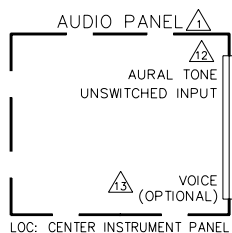
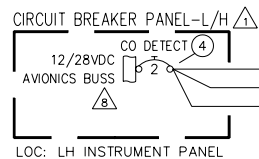

C O DETECTOR INSTALLATION WIRING DIAGRAM

<b>CO GUARDIAN</b>		1991 Elm Airport Circle Tucson, AZ 85705	
TITLE CO DETECTOR INSTL.			
DRAWING NO.	SH	REV	REV
01-553-01	3	3	1R

FILENAME: 01-552-01R2